

## MOI8-REC

Ordering Information	Description:
Slab Thickness:	 <b>LEW ELECTRIC FITTINGS COMPANY</b>
Single Rec: <input type="checkbox"/> 15A <input type="checkbox"/> 20A	
Duplex Rec: <input type="checkbox"/> 15A <input type="checkbox"/> 20A	
Cover Type:	
<b>Proprietary and Confidential</b>	DWG. No. <b>MOI8-REC</b>
The information contained in this drawing is the sole property of NOCOM. Any reproduction in part or as a whole without the written permission of NOCOM is prohibited.	

# Articulated Hinge Cover with Cable Exit Door (AHC-CED)

Cover Fully Closed

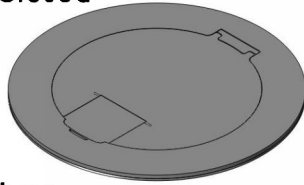

Cover CED Open

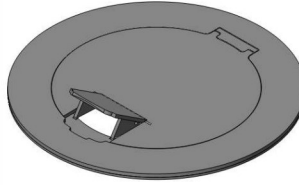

Cover Fully Open

## Cover Finishes

- Standard = Brushed Stainless Steel
- \*Custom = Brushed Brass  
or  
Black Matte
- \*Additional cost may apply
- \*Other colours/finishes available upon request

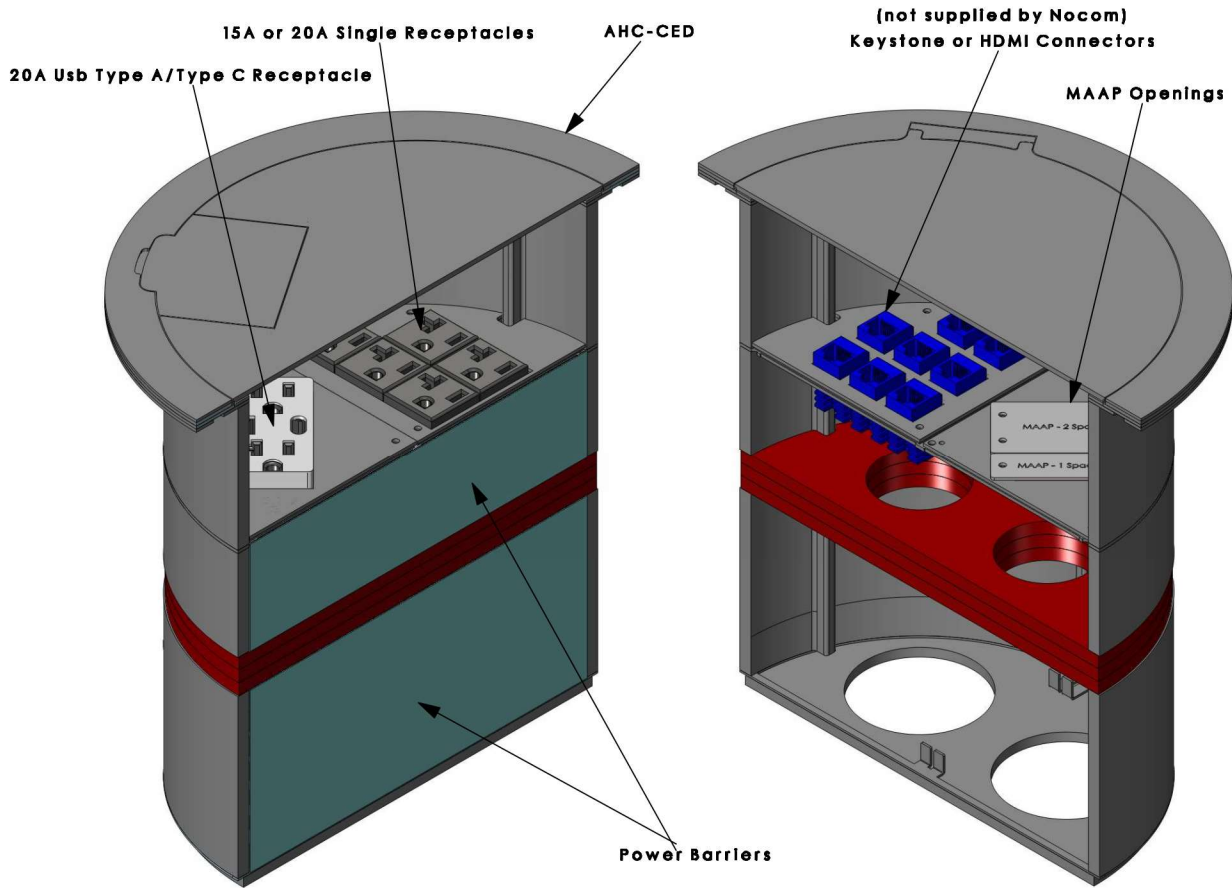

## MOI8-REC (Isometric Cross Section Views)

Ordering Information	Description:
Slab Thickness:	 <b>LEW ELECTRIC FITTINGS COMPANY</b>
Single Rec: <input type="checkbox"/> 15A <input type="checkbox"/> 20A	
Duplex Rec: <input type="checkbox"/> 15A <input type="checkbox"/> 20A	
Cover Type:	
<b>Proprietary and Confidential</b>	
The information contained in this drawing is the sole property of NOCOM. Any reproduction in part or as a whole without the written permission of NOCOM is prohibited.	
DWG. No.	MOI8-REC

# Connector Plate Options

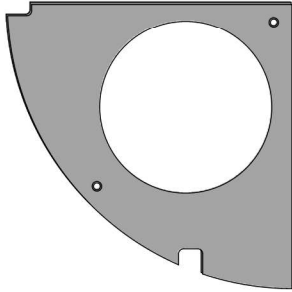

2" NPS Connector Plate

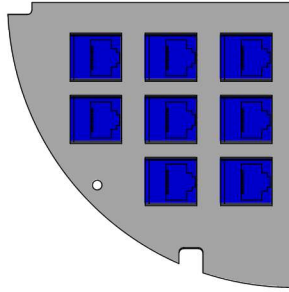

Comm 8 Connector Plate  
(Keystone or HDMI - Not supplied by Nocom)

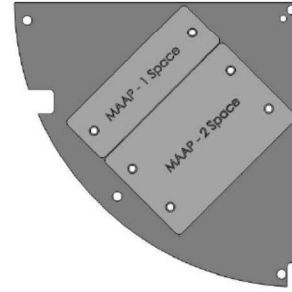

MAAP Connector Plate

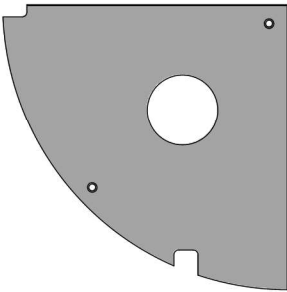

3/4" NPS Connector Plate

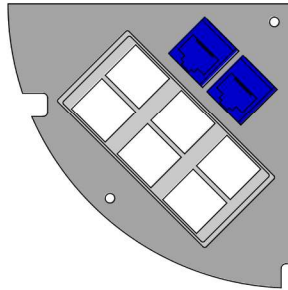

DPC-Comm 2 Connector Plate

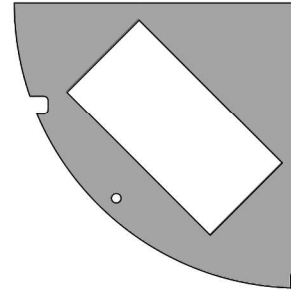

AV Connector Plate

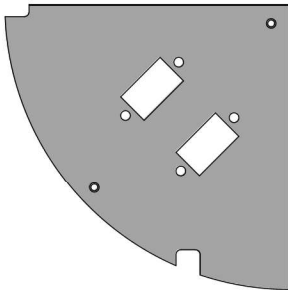

DB15x2 Connector Plate

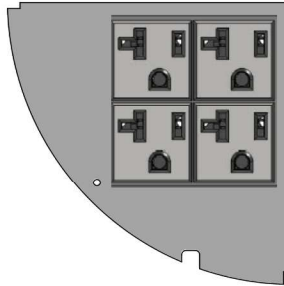

Power 4 Connector Plate  
(15A or 20A Single Receptacles)

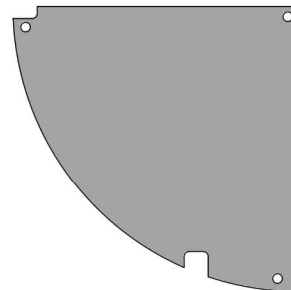

Blank Plate

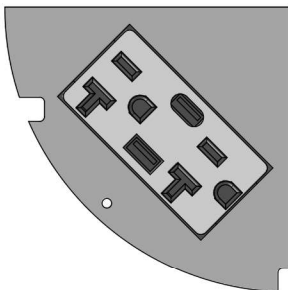

Decora Connector Plate  
(\* 15A or 20A, Usb Type A/Type C Receptacles)

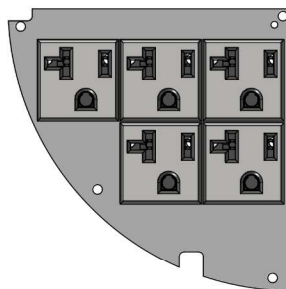

Power 5 Connector Plate  
(15A or 20A Single Receptacles)

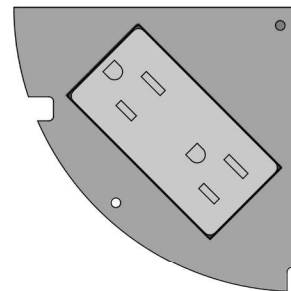

Duplex Connector Plate  
(15A or 20A Receptacles)

\* Additional costs will apply.

Ordering Information	Description: PT8 Various Quadrants
Slab Thickness:	
Single Rec: <input type="checkbox"/> 15A <input type="checkbox"/> 20A	
Duplex Rec: <input type="checkbox"/> 15A <input type="checkbox"/> 20A	
Cover Type:	
<b>Proprietary and Confidential</b>	
The information contained in this drawing is the sole property of NOCOM. Any reproduction in part or as a whole without the written permission of NOCOM is prohibited.	
DWG. No.	

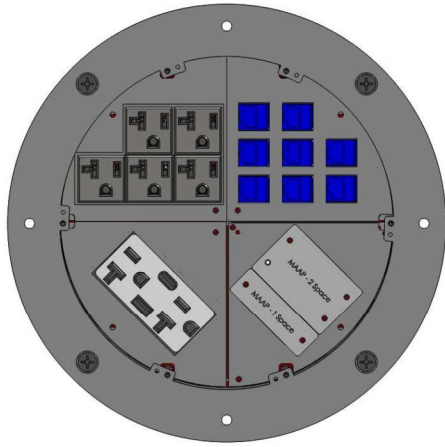

## Configuration View

Power: x5  
 Comm: x8  
 DP: x1  
 MAAP: x1

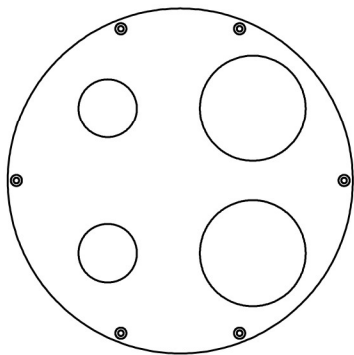
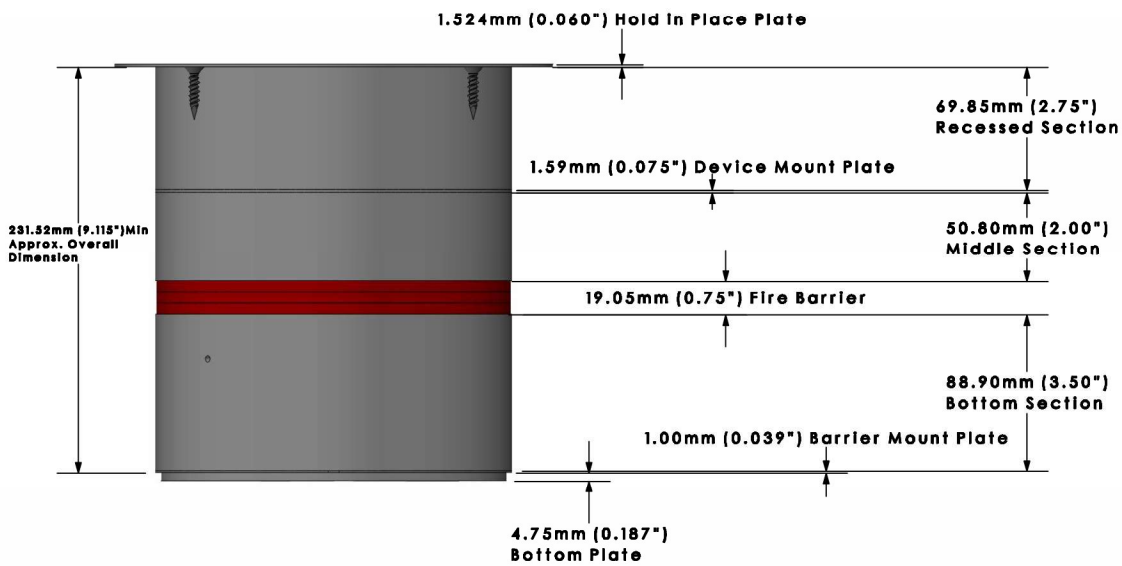

## Removable Bottom Plate

- 60.32mm (2.375") x2  
 - 33.32mm (1.312") x2

Ordering Information	Description:
Slab Thickness:	
Single Rec: <input type="checkbox"/> 15A <input type="checkbox"/> 20A	
Duplex Rec: <input type="checkbox"/> 15A <input type="checkbox"/> 20A	
Cover Type:	
<b>Proprietary and Confidential</b>	
The information contained in this drawing is the sole property of NOCOM. Any reproduction in part or as a whole without the written permission of NOCOM is prohibited.	
DWG. No.	MO18-REC